

Round container 10ml/ 50mm sealing

Product code: 00028121







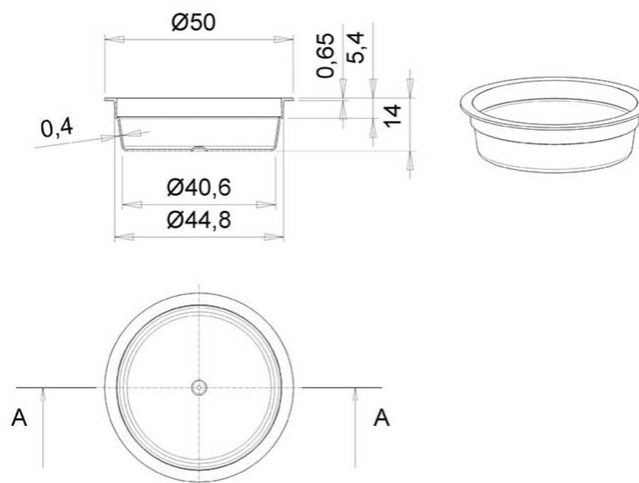

Volume, ml	10
Lid size, mm	50
Height, mm	14
Base shape	Round
Side wall shape	Straight
Types of closures	Heat Sealing
Types of lids	-
IML on body	-
IML on the lid	-









Minimum order quantity	Body	Set
Pieces per box	1 050	1 050
Logistics	Body	Set
Pieces per box	1 050	1 050
Box size (mm)	360x300x130	360x300x130
Box weight with product (kg)	1,8	1,8
Volume (m3)	0,017	0,017
Quantity of boxes (pcs)	1	1
Quantity in pallet (pcs)	77 700	77 700
Pallet weight with goods (kg)	156	156
Pallet height with goods (m)	1,83	1,83



-  Fish processing
-  Dairy products
-  Confectionery

-  HoReCa
-  Fats & Oils
-  Cooking

-  Laquers & Paints
-  Pet food
-  Cosmetics

-  Fasteners
-  Fishing gear
-  Household chemicals

